

Casio DM100 Sampler 16x sample expansion modification

by Graham Meredith, 2013
gmeredith1@yahoo.com.au
www.warningwillrobinson.com.au

Revised 8th March 2013

This is a modification to expand the sampling memory of the Casio DM100 to 16x the original sample capacity. It creates 16 separate DM100s sample banks – each “bank” is a complete DM100 memory bank of 4 samples.

The total cost of the expansion should be around \$US80

Each bank is accessed by switching a 16 position rotary switch to choose the current sample bank memory. Each memory contains four 0.7 second samples – just like the original DM100 memory.

The down side of this expansion is that you can't use a sample, from, say, memory bank 1, and another sample from memory bank 2, and put them into the same bank or sequence. **Each memory is isolated from the other.**

Please read the limitations of this expansion on the last page of this guide.

PART REQUIRED

Shrink wrap
10Kohm resistors (4 of)
Soldering iron and solder
Rainbow cable, 1 Metre

32-Pin IC Socket:

http://www.jameco.com/webapp/wcs/stores/servlet/Product_10001_10001_105381_-1



Texas Instruments NVSRAM 512Kx8 IC non-volatile BQ4015YMA-70: ----- \$61.73

[http://www.newark.com/texas-instruments/bq4015yma-70/ic-nvsram-4mbit-70ns-dip-32/dp/74C7730?in_merch=Popular Memory Products](http://www.newark.com/texas-instruments/bq4015yma-70/ic-nvsram-4mbit-70ns-dip-32/dp/74C7730?in_merch=Popular%20Memory%20Products)

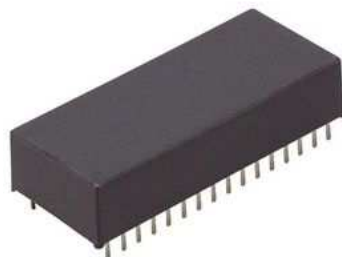

ROTARY ENCODER 4 BIT, push button wheel: ---- \$7.30

<http://www.altronics.com.au/index.asp?area=item&id=S3316A>

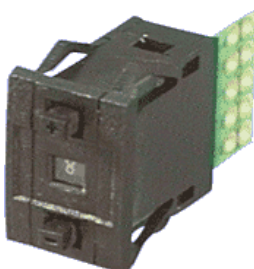

Introduction

Study the datasheets comparing the DM100 original SRAM chip - a 28pin 32k x8bit SRAM and the new 4Mbit NVRAM. They have their address & data lines mostly the same locations. The differences are the **4Mbit** chip has 32 pins and pins 1, 2, 30 & 31 are the highest address lines. Pin 32 is the power supply pin, called **Vcc** (+5V).

Vss is the same as the **GND** pin on both chips and are in the same place (though different numbers).

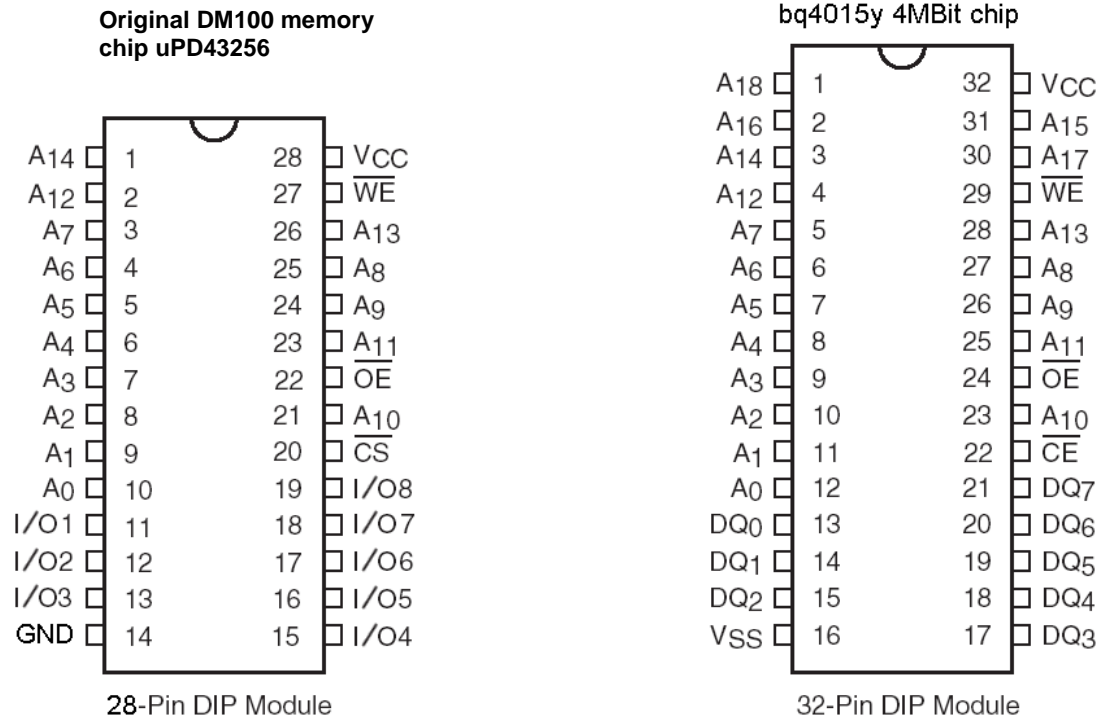

Disclaimer

This sample modification is quite involved and should be done at your own risk. I claim no responsibility for any damage done to yourself or your equipment as a result of doing this modification. Always do these modifications with any mains powered equipment unplugged and switched off, and use anti-static wrist bands to minimize damage to electronic components.

Procedure:

Lay the keyboard face-down on a padded bench. Undo the many screws on the back casing and remove it.

Disconnect the red and black battery wires on the back casing from the circuit board – unsolder them and remove the back casing, it will get in the way.

- 1) Prepare a 32 pin IC socket. We will use this to mount the new chip in. In my case, I couldn't get a 32 pin socket readily, so I cut down a 40 pin socket I had:

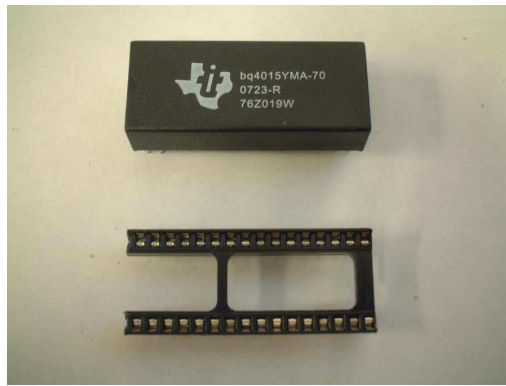
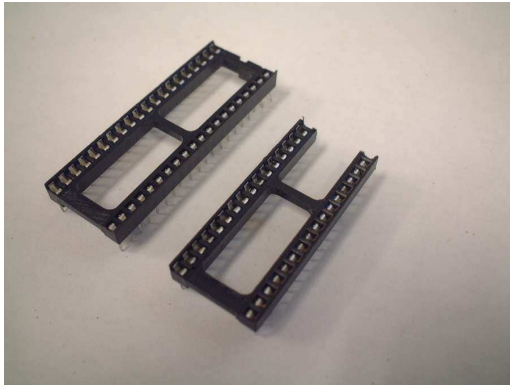

Bend the 4 right hand side upper legs out flat and then up.

Bend the 2 left hand side upper legs out flat and then up.

Solder a 3" long **red wire** to the top right hand side leg. This is our new +5V power supply leg to the chip:

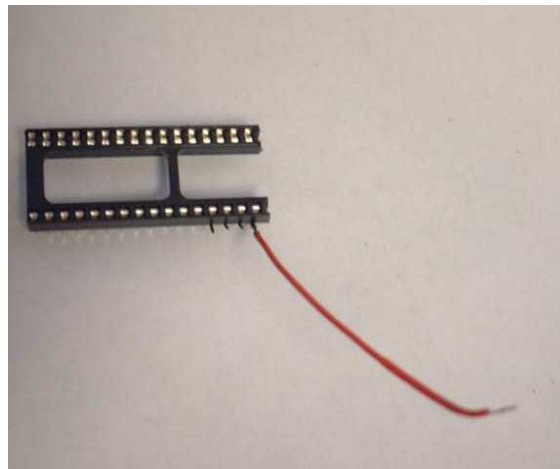
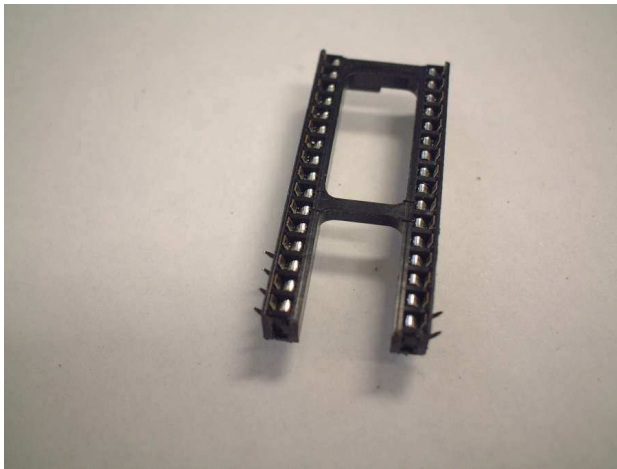

Cut a piece of coloured wire about 4" long. I chose **green**. This is WE (Write enable) wire.

Solder one end of the **green wire** to the 4th upper right hand side pin (the WE pin) on the socket. Leave the other end loose for now.

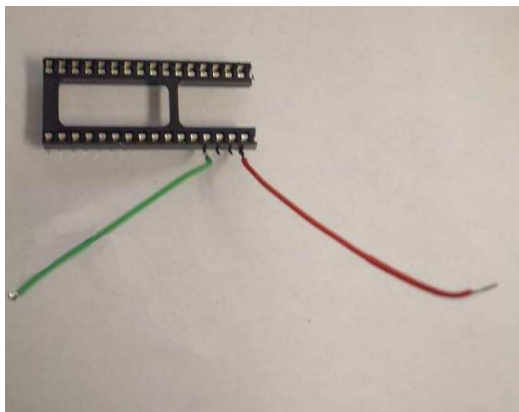

2) Take 4 10Kohm resistors. Cut 4 lengths of thin heat shrink tubing, just slightly shorter than the resistor wire's length.

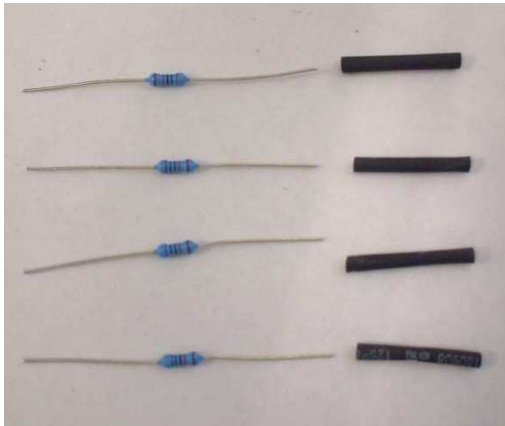

Cover one leg of each resistor with the shrink tubing, and shrink it on. Make sure some wire is exposed at each tip to allow soldering of the resistor. Also expose where the wire reaches the resistor, for soldering.

Solder each of the other ends of the resistors together in pairs. Cover these joined ends with shrink tubing, leaving a small amount at the end exposed.

Solder the free ends of the resistors as show to each of the socket pins:

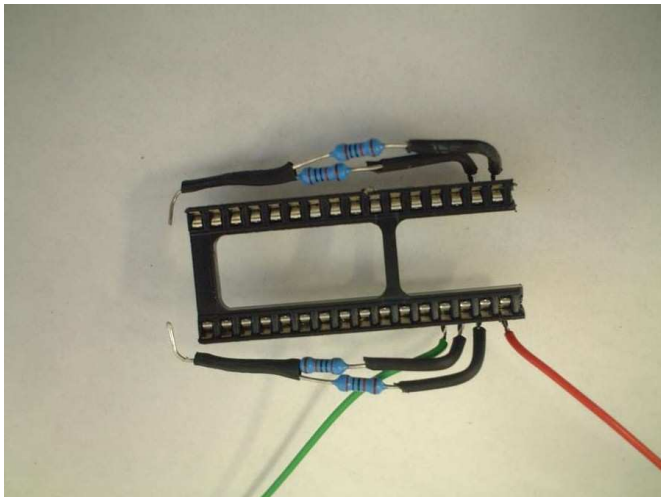

Join these combined resistors together with a black wire. Connect a 3" piece of black wire to this end join.

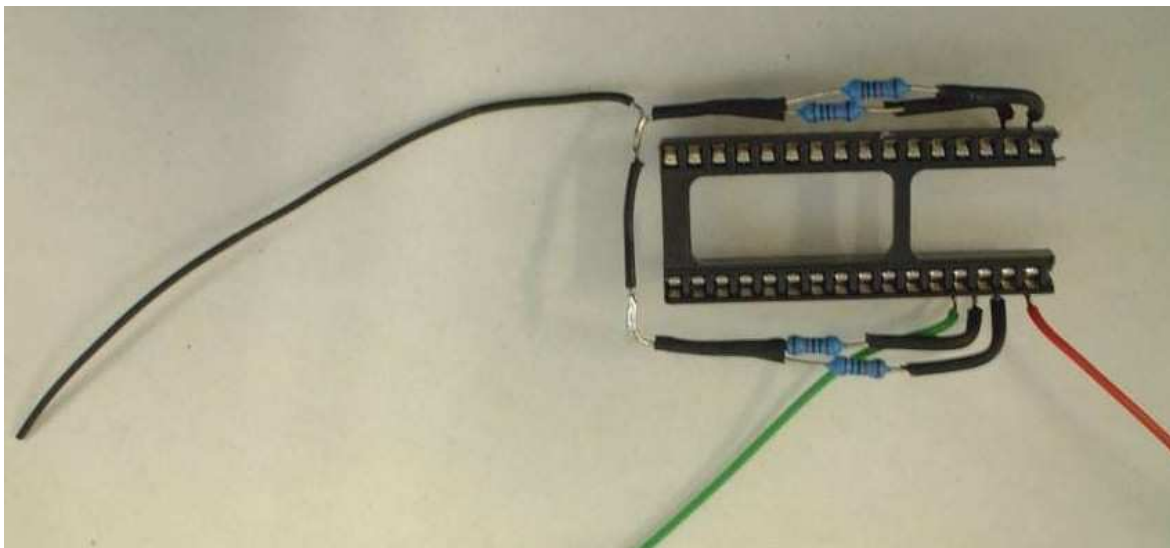

- 3) Take your socket and check your work. You can sit it loosely on top of the existing RAM chip just to see how it looks. It will give you an idea how it will look when the old chip is removed and the socket is installed.
- 4) Cut and trim piece of ribbon cable 5 wires wide, about 20" long. Use colours that have one side as the **red wire**, eg. **Red**, orange, yellow, green, blue. Trim back the other colours except **red** on one end, so that the **red wire** is about 3" longer than the others.

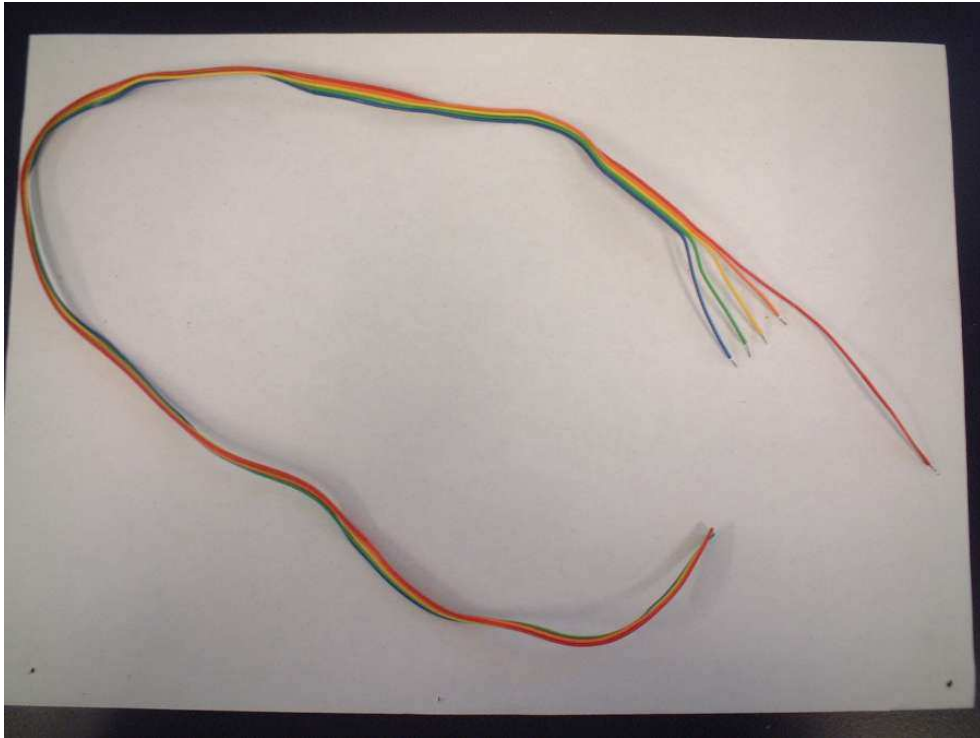

Solder the **orange**, **yellow**, **green**, and **blue** wires to the front ends of the resistors.

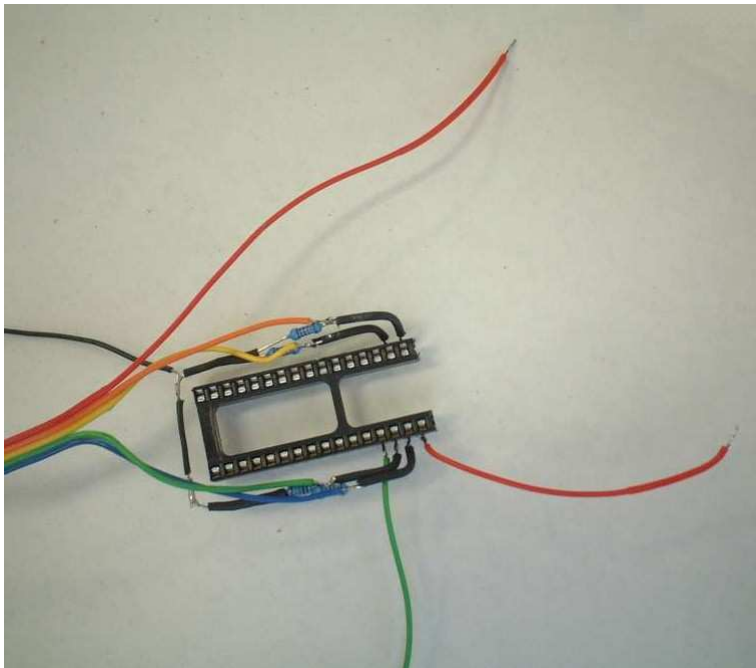

Solder the other ends of the **orange**, **yellow**, **green**, and **blue** wires to the terminals labeled 1, 2, 4 and 8 of the rotary encoder. Solder the **red wire** of this end to the terminal labeled "C" of the rotary encoder.

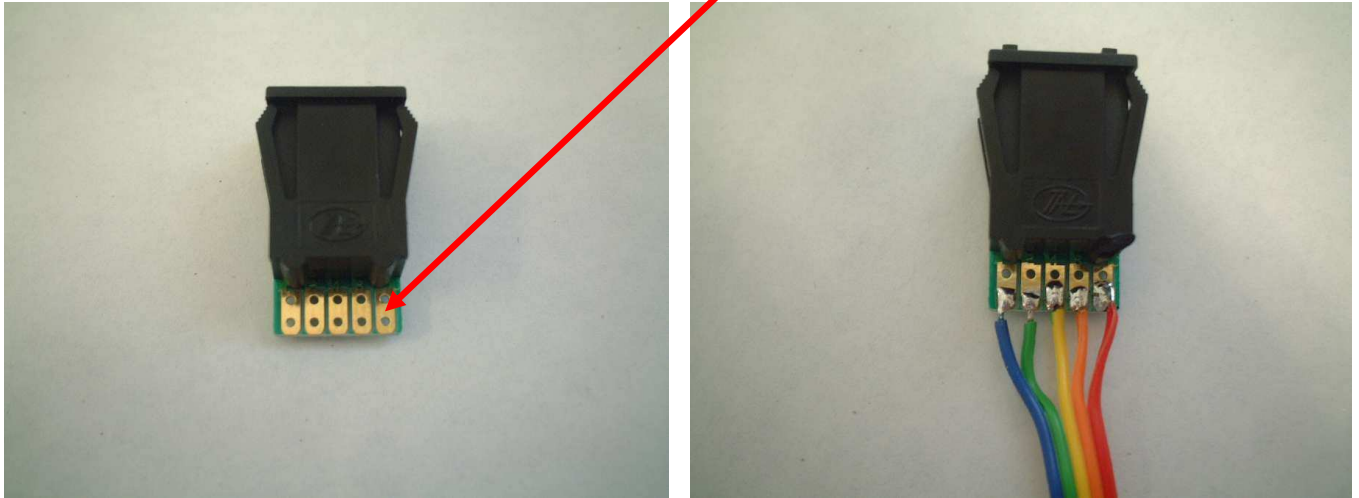

This cable is probably very excessively long when mounted in the DM100, but for now it is good to have it long until you decide where you want to mount the encoder switch. Just cut the cable when you decide and reconnect it to the encoder with a more convenient length when you're ready to mount it.

You should now have a setup that looks like this:

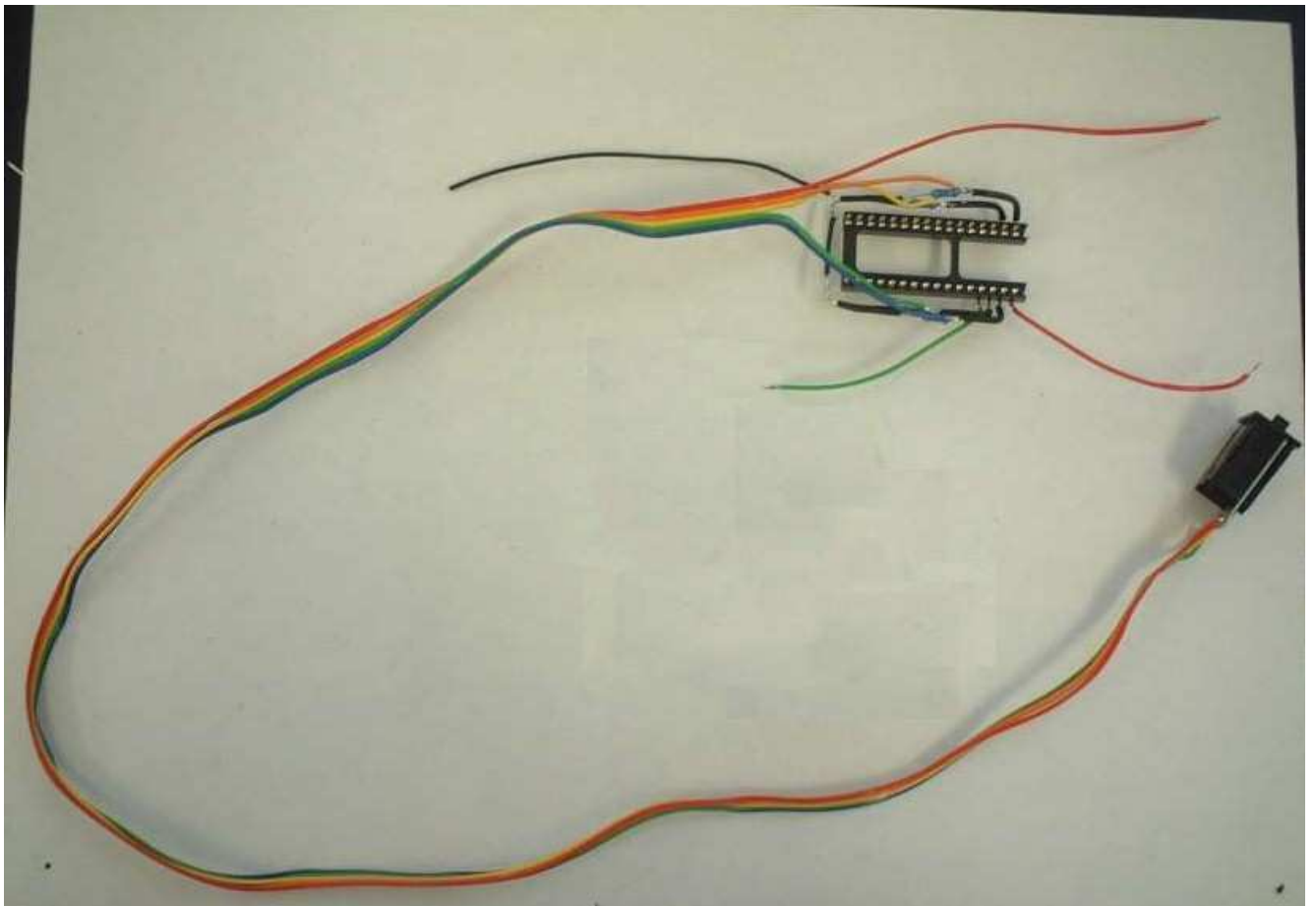

You're almost there.

Removing the old RAM chip NEC D43256-12L

Unscrew the big screws holding down the circuit board. Carefully lift it up with all wires still attached. Study it carefully and identify the areas we will be working on – the RAM chip.

- 1) Remove the old RAM chip. This is done using a fine tipped soldering iron solder sucker bulb, or de-soldering wick:



On the circuit track side of the board, identify the pins of the RAM chip. While heating each solder pin point, suck out the solder or absorb it using the de-soldering wick. I personally prefer the de-soldering wick.

Once the solder is removed and each pin of the chip is exposed, gently slide a flat tipped screwdriver underneath the chip on the other side of the board and carefully wedge it in and lift it gently. The chip may start to move. If not, try heating each pin again as you gently pry the chip, or remove more solder. At some point when all the solder joints are removed, it will pry out. When removed, clear all the holes on the board with a soldering iron.

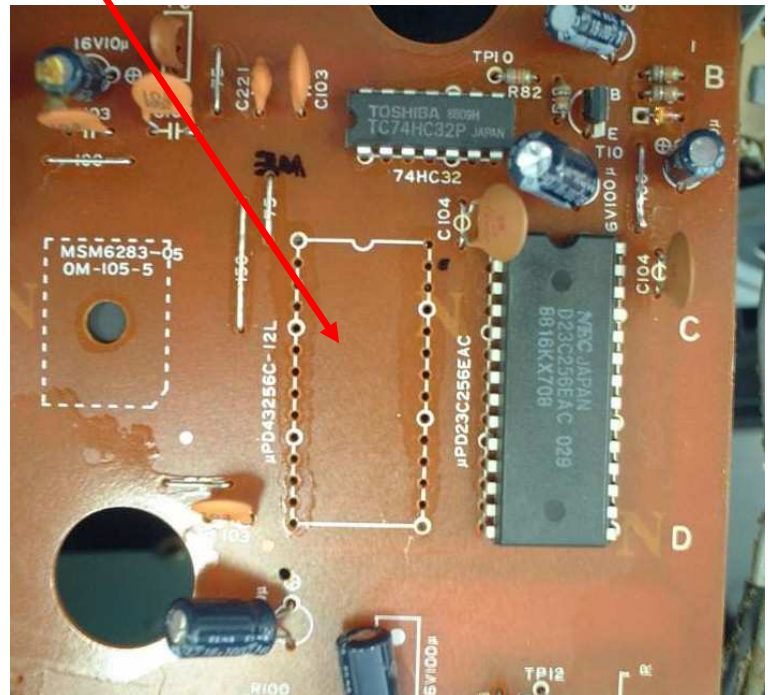
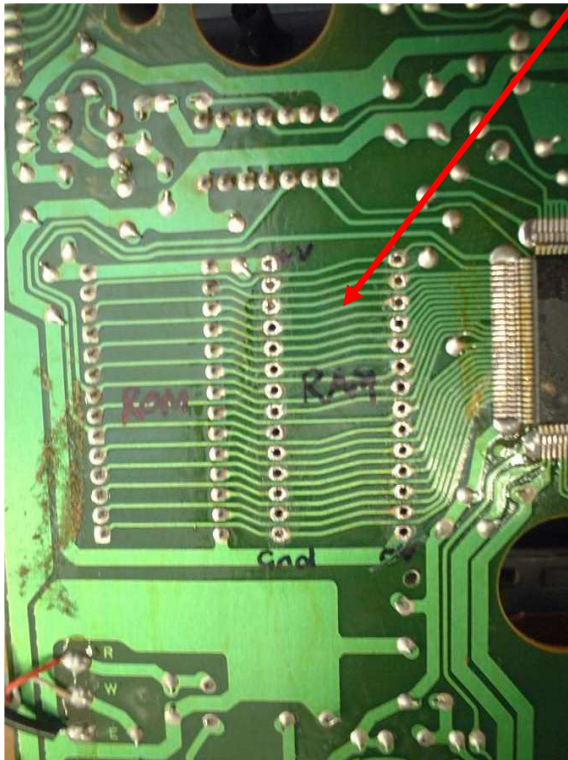

Installing the new 32 pin socket and resistors unit.

- 1) Lay the socket unit over the holes in the board where the old RAM chip used to be. Align it so that the top 4 pins of the socket overhang past the old chip boundary. The notch in the white box drawing of the board indicates the top boundary. The bottom pins of the chip should align with the bottom boundary of the old chip and sit in the same place as the old chip.
- 2) When the socket pins are aligned with the holes, gently press the socket pins through the holes and seat the socket down on the board. It should go all the way down and touch the board. Be careful that the pins go through holes and don't come out and bend underneath the chip. It should look like this if you've done it right:

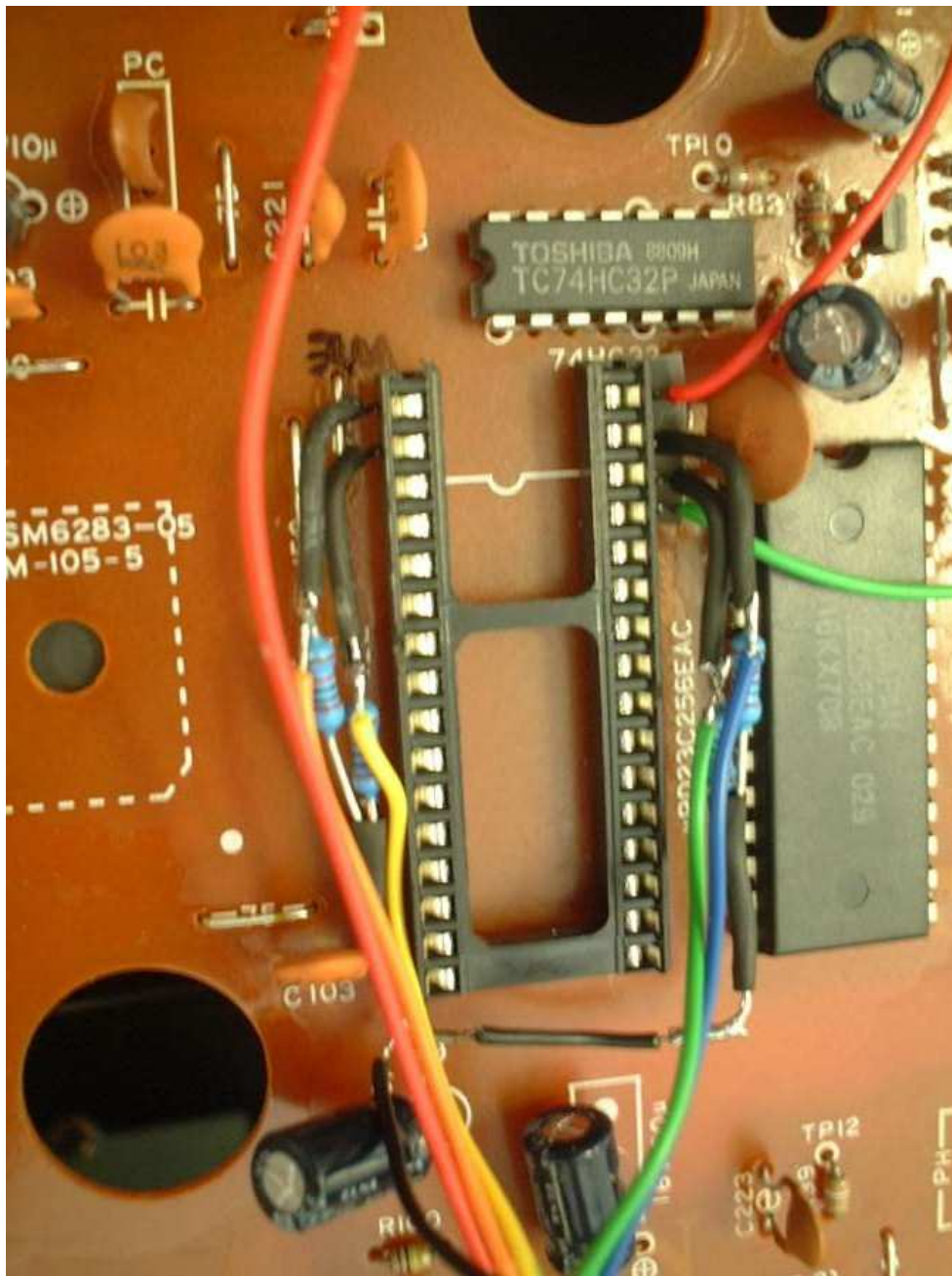

Bend over some corner socket pins on the track side while pushing the socket in place, so that the socket is held in place by itself.

Now, carefully solder the socket in place. There will be 2 socket holes on the board that will not have pins going through them in this new setup.

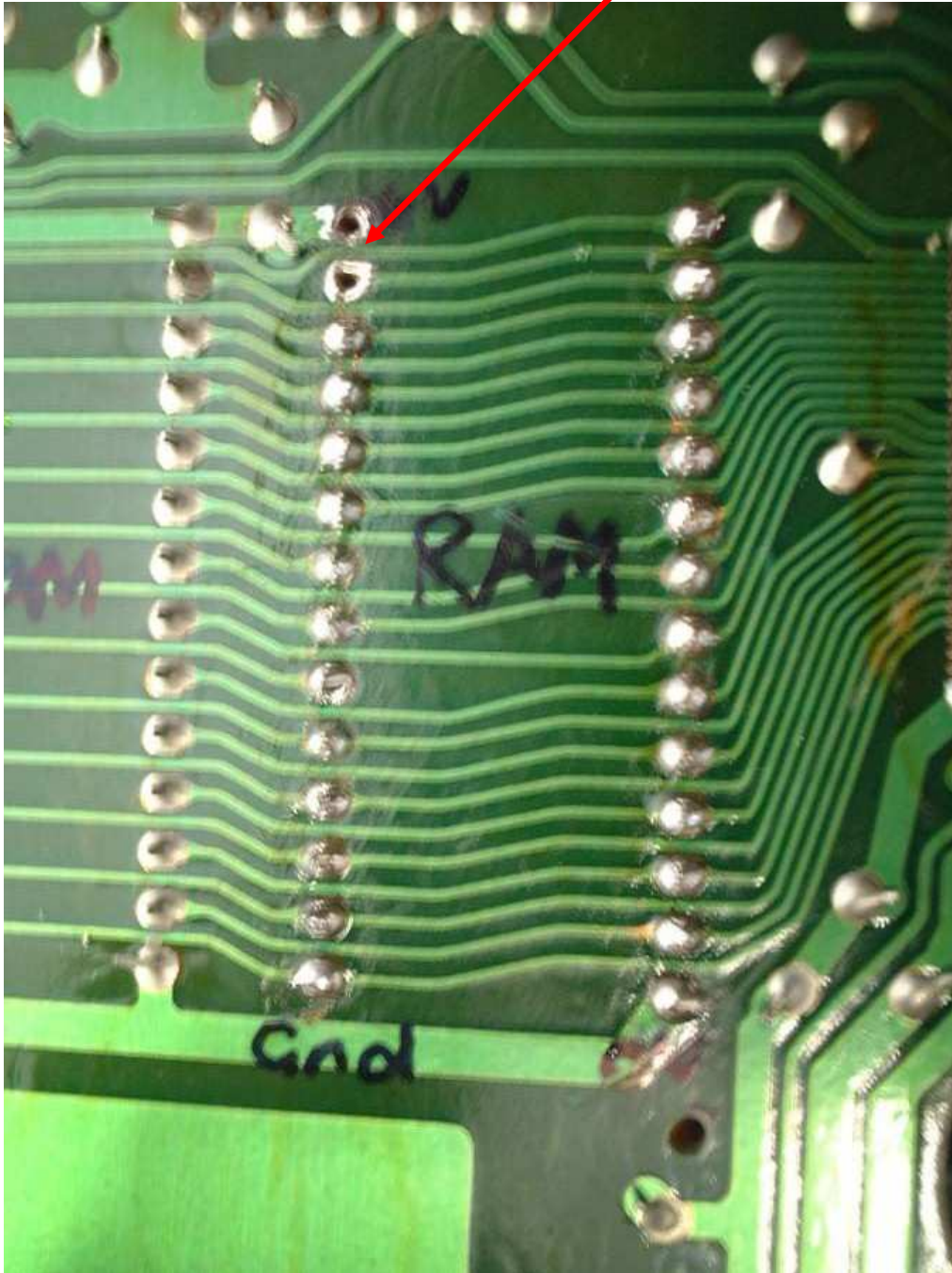

Wiring up the +5V power pin (Vcc, pin 32)

- 1) Solder the **red wire** that is soldered to the top RHS pin of the socket to the top of this silver wire jumper in the board:

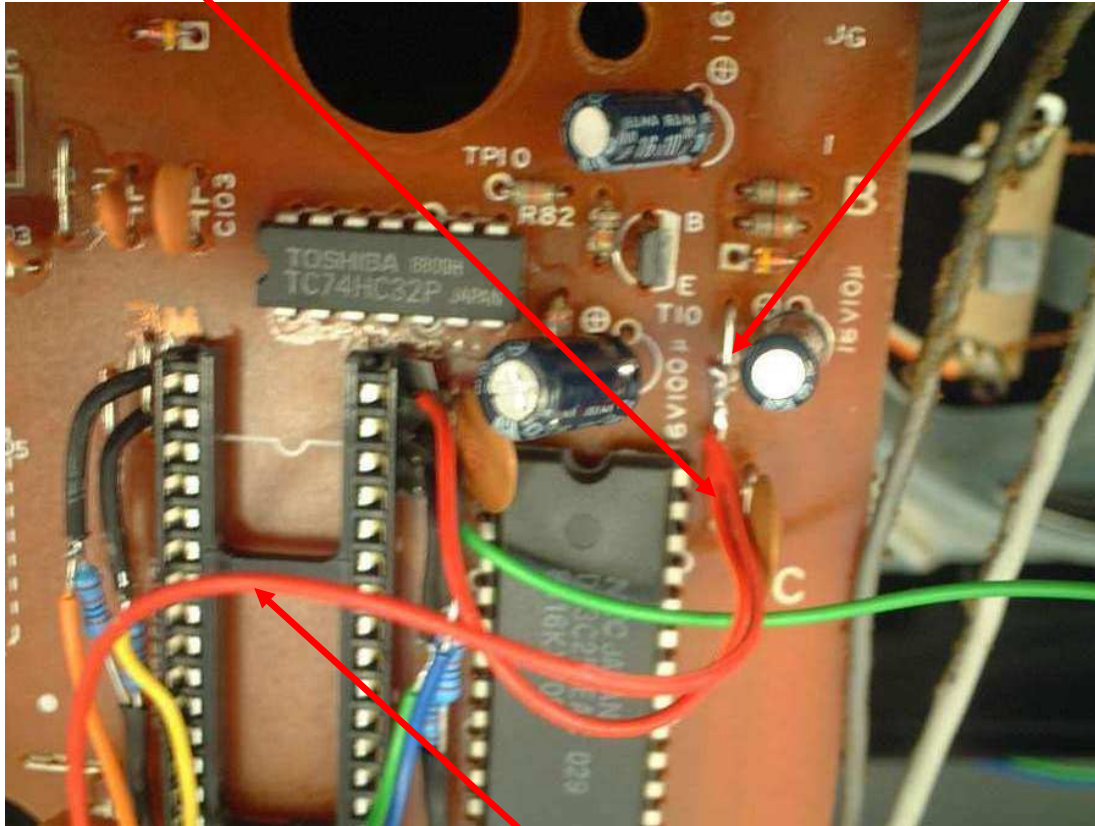

Solder the free end of the **red wire** that goes to the “C” terminal of the rotary encoder also to this same jumper. This is the power wire to the encoder. The silver wire jumper is a convenient **+5V power supply** point on the board.

Wiring up the 0V (ground) pin connection

Carefully drill a small hole in the circuit board right here:

On the socket side of the board, pass the **black wire** attached to the resistors through this hole:

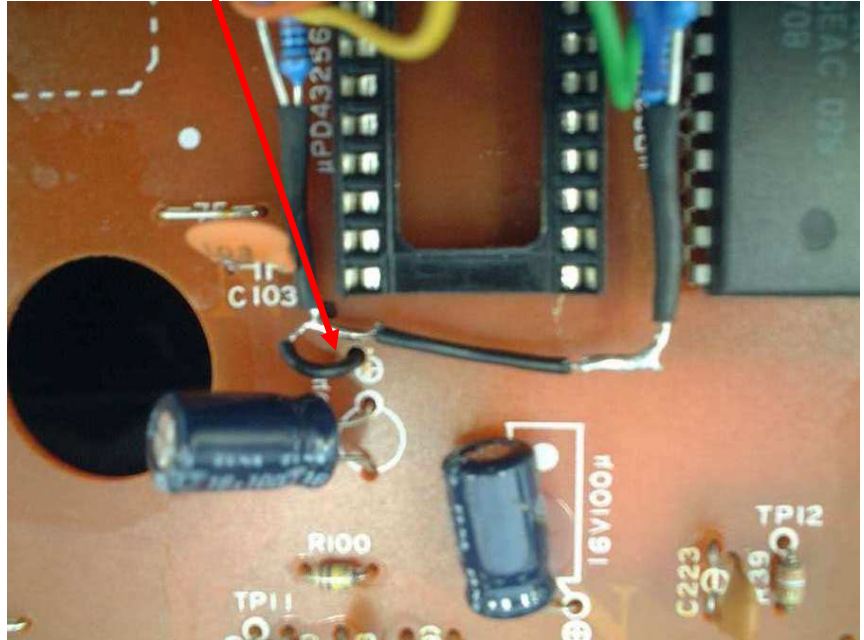
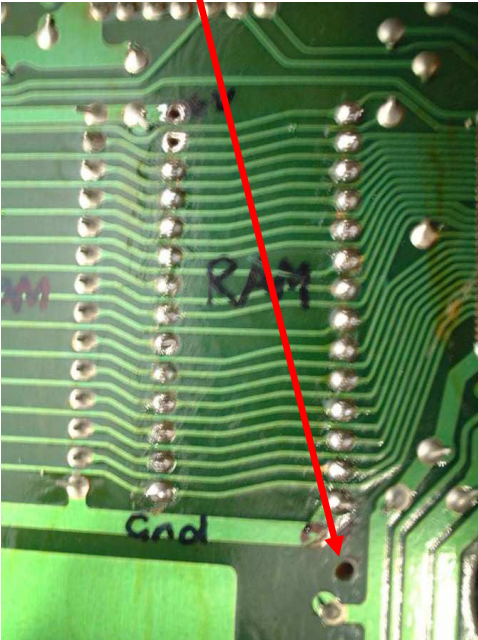

On the track side of the board, solder the other end of this **black wire** to this solder point on the circuit board:

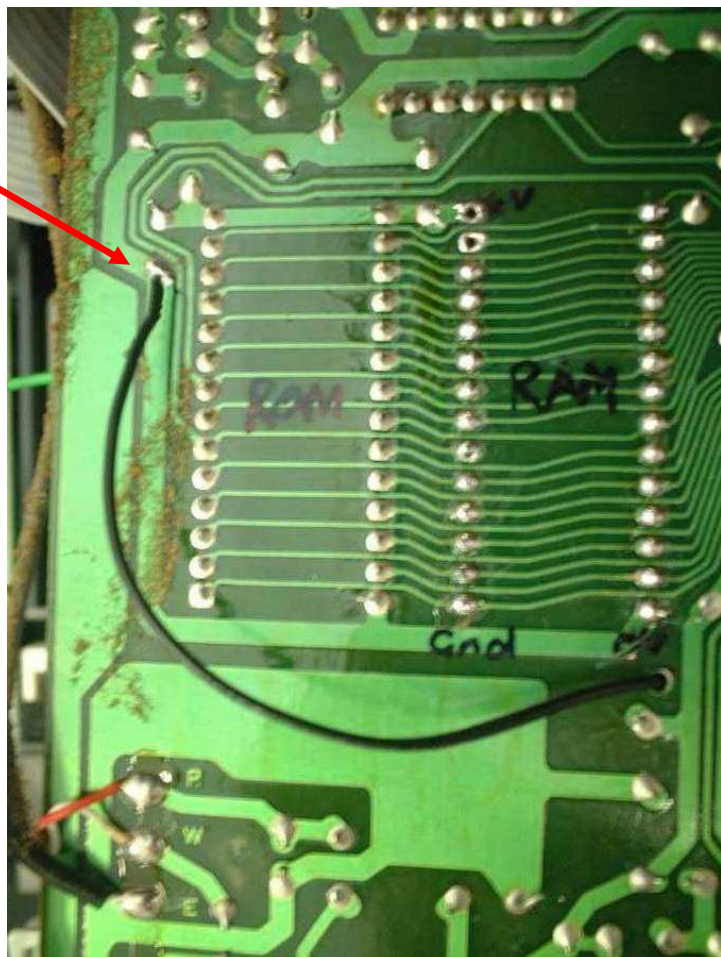

The Write Enable wire

Solder the **green WE (Write enable) wire** to the WE wire jumper next to the socket on the board.

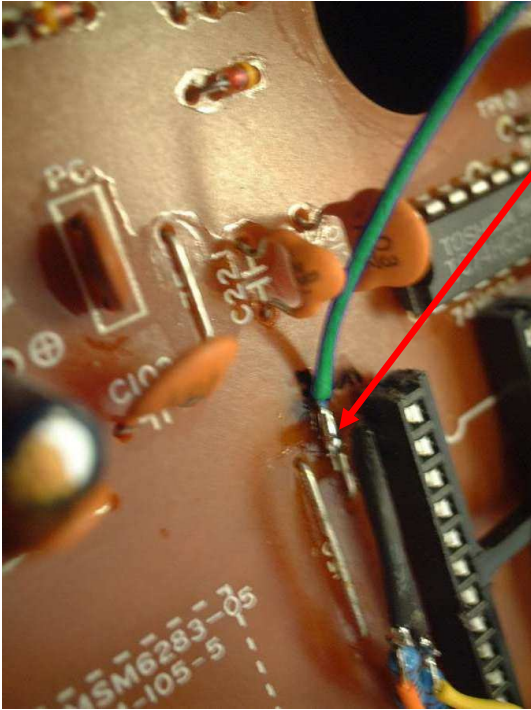

Installing the new NVRAM chip TI BQ4015y

- 1) Take the **new NVRAM chip** and rest it on top of the socket to check for alignment. Don't push it in at this stage. Make sure that the **small indent circle mark**, representing **pin 1** of the chip, is at the **top LHS** of the chip in orientation, and that the chip is sitting this way up in the board:

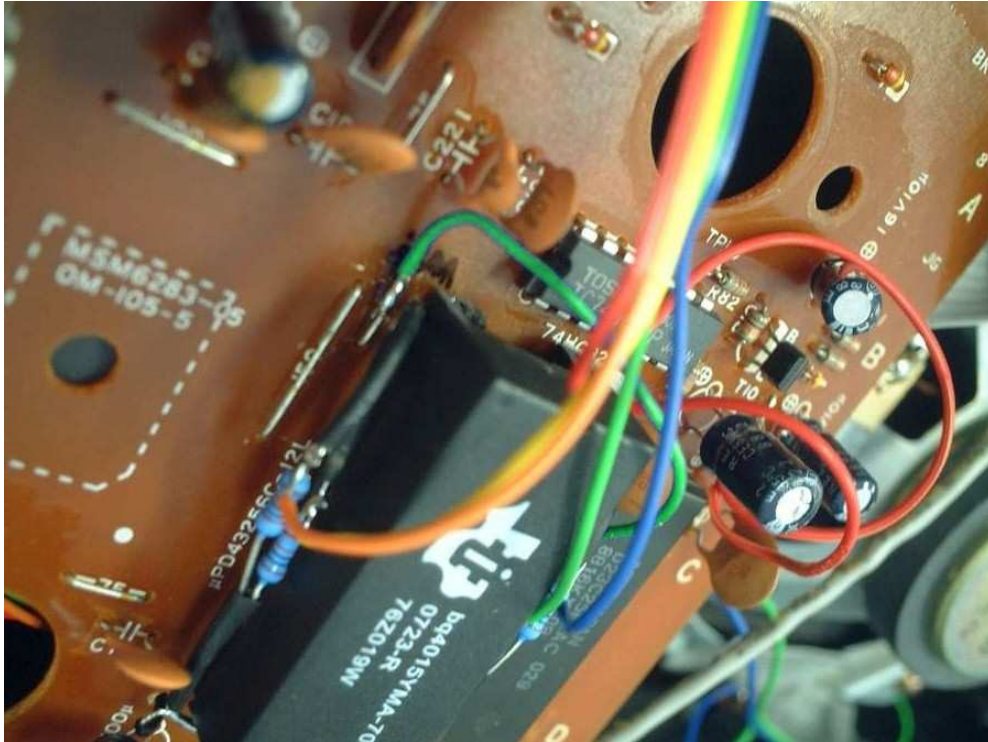

The bottom of the chip should be next to where the **black wire** is at the ends of the resistors.

If you're sure the chip is in the right spot, press firmly down on the chip and seat it positively in the socket, making sure no pins got bent outside or inside the socket, but that every one is going into a socket hole.

You're done!!

Have a good check of the chip and socket; gently move the resistors and wires around and that all the solder joints are strong and all connections are secure. Put a piece of insulation tape between the socket and the large adjacent ROM chip, to stop any short circuits from other components.

On the circuit track side, check that there are no stray solder blobs or whisks shorting out tracks on the board – use a magnifying glass to check. Clean the tracks thoroughly around the whole area.

Trying it out

Put the circuit board back in place. Just fasten it down with a couple of screws for the moment.

Leave the back of the keyboard off for the moment.

Turn the keyboard right way up and set it down on a table, propped up on books at its ends, so that the circuit board is not touching the table when resting on the books.

Dangle the encoder wires underneath it, and put the encoder coming out in a convenient spot on the table. Set it to position 0, the first position.

1) Make sure the Casio power switch is set to OFF.

Plug in the **9V DC Casio mains adapter** to mains power and switch the power point on. Plug the plug into the keyboard. The power light on the Casio **will briefly flash** then extinguish, even if the switch is off. This is normal.

Switch the keyboard on.

Test the keyboard using the bottom keyboard; select some sounds and play them to make sure the bottom keyboard is working.

Play the **top keyboard** using the preset sounds first – the piano, organ etc.

Select **sample button 1** and play it. It should have a preset sound such as the piano sound in its memory. This means at least that the sample space is working.

2) **Record a sample with sample button 1 using the inbuilt microphone.**

Say the word “**zero**” into it. You will see the reason for this soon. Make sure you speak loud enough into it to trigger the sample record trigger. Play it back.

If you have got a clean sample coming out, hooray!! That’s a good sign. Your RAM is working.

Record samples into the other **3 sample button spaces**. If they are all working fine, you’re doing great.

Things that might cause problems:

Check that the RAM chip is in the right way.

Check that all the pins are in the socket.

Check the solder joints on the socket pins are good and that all but 2 holes on the board have pins in them and soldered securely.

Check that there are no stray solder blobs or whiskers shorting out tracks on the board – use a magnifying glass to check

Assuming that you now have a fully working sampler, move on to the next test.

The Rotary Encoder

1) Change the encoder to position 1.

Select the sample 1 button.

Play the upper keyboard.

You will get a surprise!! You should hear a loud hissing noise from the speakers as you play a note.

THIS IS NORMAL!!!!!!!!!!!!!! I will explain:

The NVRAM chips come shipped with no samples in them, and unformatted. What you are hearing is the sound of the unformatted random data in that memory slot. The whole chip will be full of this.

Suggestion: Reserve an encoder memory position, such as 15, to preserve this noise – you can use it as a white noise oscillator for sounds in the DM100, which it doesn't normally have! Keep them there and don't overwrite them if you can, because once you write a sample into them, you will structure the data and format the chip in that memory slot and you will never get it back again, because the memory chip retains its data for at least 10 years!!

2) **In encoder position 1**, use the sample 1 button and record a sample - speak the number "one" into it as the sample. Play it back.

If it is good, change the encoder back to the 0 position, and play your previous sample in that bank. Is it still saying "zero" If it is, then all is good. Switch back to encoder bank 1. Is it still saying "one"? Well done if it is.

Do the same again for encoder bank position 2, recording the word "two" into it. Play it back. Change back to bank 1 and 0 again and play them. If they are all sounding the correct sample for that bank, you're well on the way.

Continue on in the same manner, recording with the sample 1 button through **all of the banks** except for bank 15 (the last one) – leave it blank if you wish as a noise bank.

Scroll back through each bank, checking that the sample sound is the same as the bank number.

If you get all the way from bank 0 to 14 (or 15 as well if you don't care about retaining a noise bank), you have a fully expanded DM100!! Congratulations!

You can now go and fill in the other sample button selections 2, 3 and 4 in each bank. It will take a long time to do – 64 samples is a fair bit!!

If all is well, switch off the instrument, unplug it and re-solder the wires to the battery casing that we removed at the very start of the process.

Replace all of the circuit board screws and check that the board is fully fastened. Tie back any cables and wiring that may be in the way.

Mounting the encoder in the casing.

Find a convenient place you would like to mount the encoder on the front casing of the keyboard. Carefully cut a rectangle hole and file it out to snugly fit the encoder body.



De-solder the wires to the encoder, then push the encoder body through the top of the casing and press it flush with the casing surface.



Re-solder the encoder wires.

Replace the back casing and do up all the casing screws.

You are finished! Enjoy!

Troubleshooting problems

If, after recording something on each bank, you hear the same sample repeated in certain banks (eg bank 1, 5, 9, 13 etc) this indicates that there is a bad wiring connection to the encoder, or a bad encoder.

Re-solder the wires going to it, and check there is no stray solder or thin wire bridging the terminals – check with a magnifying glass. This happened to me the first time. Also check the resistors on the socket have good connections, and also their wires.

Physical limitations to the Modification

Because the DM100 doesn't store EVERYTHING in its SRAM, certain things about the sampler are actually only stored in the microprocessor, which you cannot upgrade.

What is stored in SRAM

Sample data (including reversed effect)
Sequencer Data

What's not stored in SRAM

Tuning of each sample
Envelope effect applied to sample
Whether a sample is recorded as long or short

If you have a mixture of LONG and SHORT samples in different banks, the DM100 will only remember what the four sample pads are as if there was ONLY ONE bank. That means you have to "tell" the DM100 what the samples are (long/short) if you're switching between banks and the sample orientation changes. Also, if you leave the batteries out of the DM100, it will actually forget that there are even samples there at all (even though they still are).

This is where having one bank just reserved for setting the samples is handy. If you call up this bank, say bank 0, you can then press, for example, SAMPLE 1 -> SAMPLE LONG, and you can restore the settings intended for that sample in that bank when you switch over to the other - simply reserve a bank (bank 0) for resetting the DM100 whenever it has lost battery power and has "forgotten" the samples or their effects. If you re-record any random sample into the 4 sample memories of bank 0, when you now change to the other banks, all your samples will still be there the way you recorded them.

Using alternative standard SRAM and backup battery instead of the TI BQ4015y NVRAM

After expanding my own SK8's sample memory, and now the DM100, I've been thinking about the possibility of using cheaper SRAM expansion chips compared to what I have just used, and installing a memory battery, independently of the AA batteries in the keyboard. Anyone owning an SK5/ SK8 would know that if the AA batteries die, you lose your samples.

My SK8, which has its sample memory expanded to 32x, and also the DM100 which is 16x, have a special NVRAM chip I used for the expansion - a Texas Instruments BQ4015y chip. This chip has a special lithium battery built into the chip, with an expected battery life of 10 years+.

If the AA's go flat, my samples are still retained by the chip. But the chip is getting hard to get and is very expensive, so I thought that I might explore the possibility of using a lithium button cell battery to do the same thing as the BQ4015y chip's battery, but using cheaper standard SRAM for the expansion - and use a CR2032 coin cell battery that is used in so many synths for memory backup.

It should be easy to do. All you should need to do is get one of those coin cell battery holders, two signal diodes (IN4148 should do) and a CR2032 coin battery. Connect a diode to the +5V power circuit track trace that goes to the expansion SRAM chip power pin (pin 32 on a 16x expansion SRAM chip). Connect the other end of the diode to the chip pin's power pin 32, the diode pointing with the stripe facing pin 32.

Solder another diode also directly to the SRAM chip's power pin 32, again pointing with the stripe facing the pin. Now connect the other side of the diode to the + terminal on the coin button battery holder. Connect the - terminal to the ground terminal of the SRAM chip (pin 16). All you now have to do is slip the coin battery in the holder, and it should be on. If you take a multimeter and measure the voltage across the +5V power pin of the SRAM chip (with the SK switched off, unplugged, and no AA batteries in it) and pin 14 ground pin, you should get about +3V DC.

This should theoretically hold the sample memory from now on, using a sample expansion chip like an Alliance AS6C4008-55PCN:

<http://au.element14.com/alliance-memory/as6c4008-55pcn/sram-4mb-2-7v-5-5v-512kx8-pdip32/dp/1562900>